

# Inductive sensor

## NBN8-18GM50-E2-V1



- 8 mm non-flush
- Extended temperature range  
-40 ... +85 °C
- Extended operating voltage range
- Flexible use with versatile mounting opportunities



### Dimensions

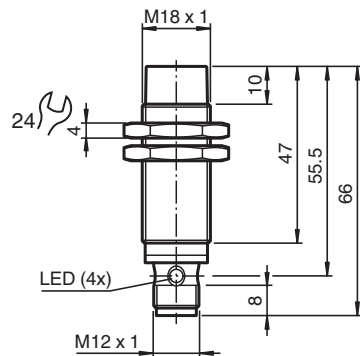

### Technical Data

General specifications		
Switching function		Normally open (NO)
Output type		PNP
Rated operating distance	$s_n$	8 mm
Installation		non-flush
Output polarity		DC
Assured operating distance	$s_a$	0 ... 6.48 mm
Actuating element		mild steel, e. g. 1.0037, SR235JR (formerly St37-2) 24 mm x 24 mm x 1 mm
Reduction factor $r_{Al}$		0.44
Reduction factor $r_{Cu}$		0.42
Reduction factor $r_{304}$		0.76
Reduction factor $r_{Brass}$		0.52
Output type		3-wire
Nominal ratings		
Operating voltage	$U_B$	5 ... 36 V
Switching frequency	$f$	0 ... 1650 Hz

Release date: 2023-01-25 Date of issue: 2023-01-25 Filename: 326161-0120\_eng.pdf

Refer to "General Notes Relating to Pepperl+Fuchs Product Information".

Pepperl+Fuchs Group  
www.pepperl-fuchs.com

USA: +1 330 486 0001  
fa-info@us.pepperl-fuchs.com

Germany: +49 621 776 1111  
fa-info@de.pepperl-fuchs.com

Singapore: +65 6779 9091  
fa-info@sg.pepperl-fuchs.com

 PEPPERL+FUCHS

## Technical Data

Hysteresis	H	typ. 5 %
Reverse polarity protection		reverse polarity protected
Short-circuit protection		pulsing
Voltage drop	$U_d$	$\leq 1$ V
Operating current	$I_L$	0 ... 200 mA
Off-state current	$I_r$	max. 20 $\mu$ A
No-load supply current	$I_o$	$\leq 10$ mA
Time delay before availability	$t_v$	$\leq 10$ ms
Switching state indicator		Multihole-LED, yellow
<b>Functional safety related parameters</b>		
MTTF <sub>d</sub>		1707 a
Mission Time (T <sub>M</sub> )		20 a
Diagnostic Coverage (DC)		0 %
<b>Conformity</b>		
PWIS conformity		VDMA 24364-A1/B2/C1/T100°C-W
<b>Compliance with standards and directives</b>		
Standard conformity		
Standards		EN 60947-5-2:2007 EN 60947-5-2/A1:2012 IEC 60947-5-2:2007 IEC 60947-5-2 AMD 1:2012
<b>Approvals and certificates</b>		
Protection class		II
Rated insulation voltage	$U_i$	36 V
Rated impulse withstand voltage	$U_{imp}$	500 V
UL approval		cULus Listed, General Purpose, Class 2 Power Source
CCC approval		CCC approval / marking not required for products rated $\leq 36$ V
<b>Ambient conditions</b>		
Ambient temperature		-40 ... 85 °C (-40 ... 185 °F)
Storage temperature		-40 ... 85 °C (-40 ... 185 °F)
<b>Mechanical specifications</b>		
Connection type		Connector plug
Housing material		brass , white bronze coated
Sensing face		PBT , green
Degree of protection		IP68
Connector		
Threading		M12 x 1
Number of pins		3
Mass		58 g
Tightening torque		0 ... 30 Nm
<b>General information</b>		
Scope of delivery		2 self locking nuts in scope of delivery

## Connection

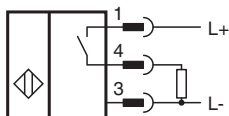









## Connection Assignment



Wire colors in accordance with EN 60947-5-2

1	BN	(brown)
2	WH	(white)
3	BU	(blue)
4	BK	(black)

## Accessories

	<b>BF 18</b>	Mounting flange, 18 mm
	<b>BF 18-F</b>	Plastic mounting adapter, 18 mm
	<b>MH 01-M18</b>	Mounting brackets for sensors
	<b>V1-G-2M-PUR</b>	Female cordset single-ended M12 straight A-coded, 4-pin, PUR cable grey
	<b>V1-W-2M-PUR</b>	Female cordset single-ended M12 angled A-coded, 4-pin, PUR cable grey
	<b>V1-G-BK2M-PUR-U</b>	Female cordset single-ended M12 straight A-coded, 4-pin, PUR cable black, UL approved, drag chain suitable, torsion resistant
	<b>V1-W-BK2M-PUR-U</b>	Female cordset single-ended M12 angled A-coded, 4-pin, PUR cable black, UL approved, drag chain suitable, torsion resistant
	<b>V1-G-BK</b>	Female connector M12 straight A-coded 4-pin, for cable diameter 4 - 6 mm, field-attachable
	<b>V1-W-BK</b>	Female connector M12 angled A-coded 4-pin, for cable diameter 4 - 6 mm, field-attachable

Release date: 2023-01-25 Date of issue: 2023-01-25 Filename: 326161-0120\_eng.pdf

Refer to "General Notes Relating to Pepperl+Fuchs Product Information".

Pepperl+Fuchs Group  
www.pepperl-fuchs.com

USA: +1 330 486 0001  
fa-info@us.pepperl-fuchs.com

Germany: +49 621 776 1111  
fa-info@de.pepperl-fuchs.com

Singapore: +65 6779 9091  
fa-info@sg.pepperl-fuchs.com

 **PEPPERL+FUCHS**